

Container/Chassis	967-984
Body Parts	968-974
Floor	968
Front Wall	969
Rear Wall	970
Roof	971
Side Wall.	972-974
Landing Gear	975
Lighting & Electrical	976-977
Safety, Security & Accessories	978-979
Suspensions	980-983
Wheel End	984

The following appendix is a selection of container/chassis parts offered. For a complete list of parts available request an Intermodal Catalog from your Aurora Regional Sales Manager or go online to www.MyAuroraPlus.com.



Appendix: Container/Chassis

Body Parts

Container/Chassis

Flooring

Crossmembers

Part Number	A	B	C	Length
CMB-CC11	80 mm.	122 mm.	50 mm.	2,400 mm.
CMB-CC12	45 mm.	85 mm.		2,400 mm.
CMB-CC13	45 mm.	100 mm.		2,400 mm.
CMB-CC14	45 mm.	122 mm.		2,400 mm.
CMB-CC15	60 mm.	120 mm.	60 mm.	2,400 mm.
CMB-CC16	60 mm.	120 mm.	80 mm.	2,420 mm.
CMB-CC17	50 mm.	120 mm.		2,400 mm.
CMB-CC18	45 mm.	122 mm.		2,400 mm.
CMB-CC19	45 mm.	85 mm.		2,400 mm.

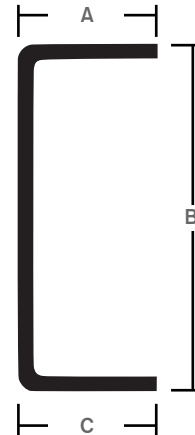

Plywood

Type	
Routed	WDS4-7
Not Routed	WDS4-7NR
Heavy Duty, Routed	WDS4-7HD



Size: 1-1/8 in. x 4 ft. x 8 ft.

Intermediate Crossmember Repair Kit

CMB-CC04

Cross Ref: CIMC#MFP54224

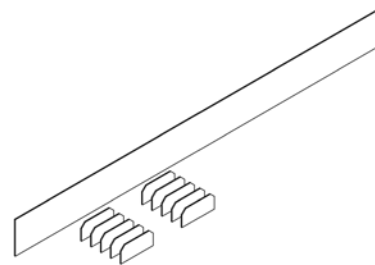

Reinforcement Patch

Location	
Roadside	CMB-UN01
Curbside	CMB-UN02

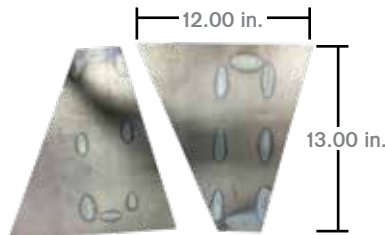

Body Parts

Front Wall

Front Corner Posts

Part Number	Length	A	B	C	D
CNR-CC11	2725 mm.		245 mm.	229 mm.	
CNR-CC12	2400 mm.	46 mm.	225 mm.	209 mm.	56 mm.
CNR-CC13	2700 mm.		225 mm.	209 mm.	
CNR-CC14	2725 mm.		245 mm.	229 mm.	

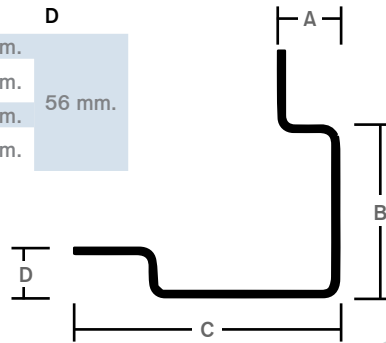

Front Corner Post CNR-CC01

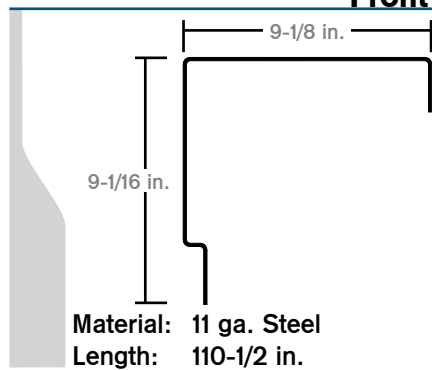

Front Corner Post

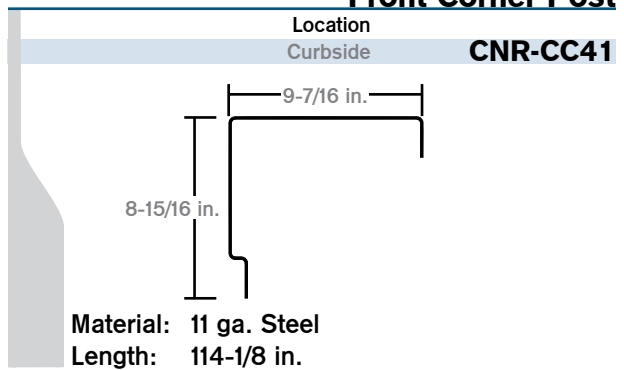

Front Corner Post CNR-SG01

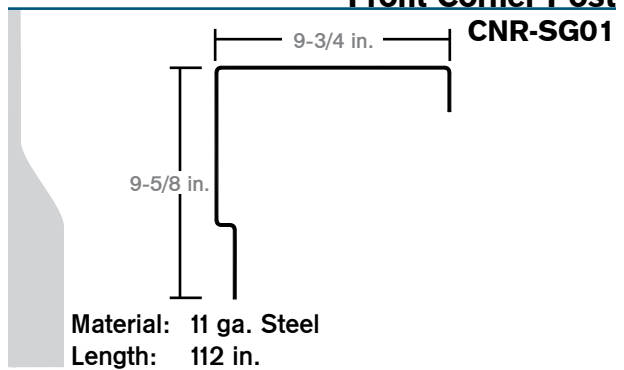

Container/Chassis

Appendix: Container/Chassis

Container/Chassis

Body Parts

Rear Wall

Bumpers

Hyundai Style

Part Number	Cross Ref:	Type	Length	Material
BMP-HY02	20044010	Bolt-On Bumper Assembly, ICC Complete	94 in.	Steel
BMP-HY05	20006721	Bumper Assembly, ICC	94 in.	Steel
BMP-HY06	20068070	Bolt-On Bumper Assembly	94 in.	Steel, Gray Primer

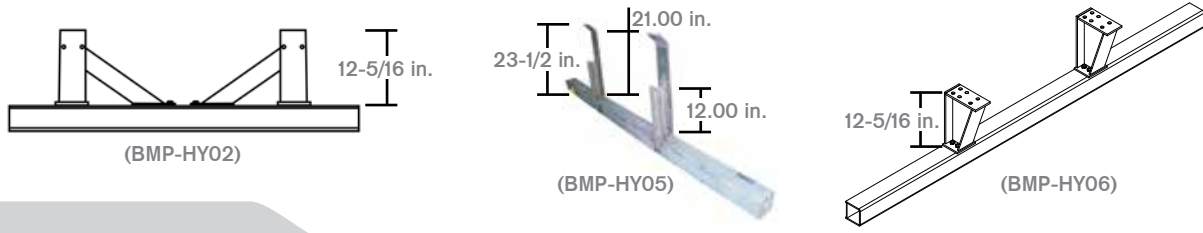

Rear Corner Post CNR-CC10W

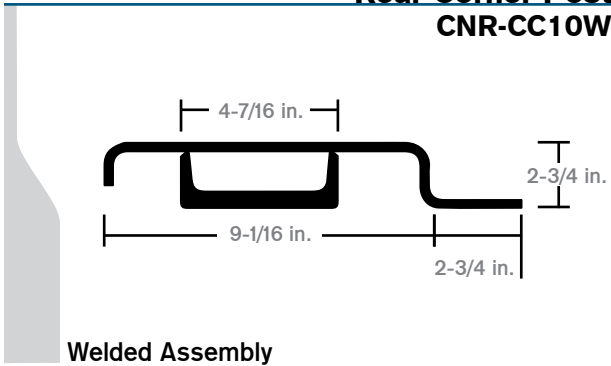

Rear Corner Post CNR-CC19

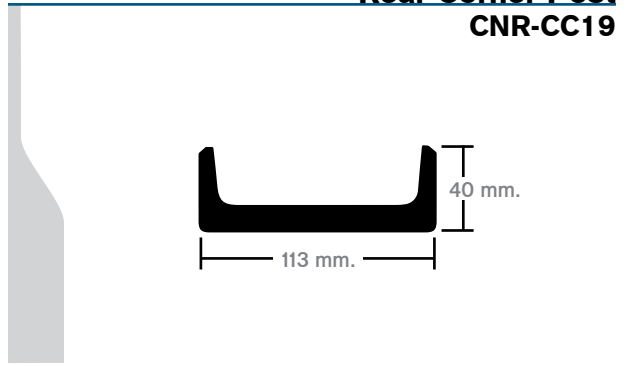

Rear Corner Post

Part Number	A	B	C
CNR-CC16	40 mm.	50 mm.	232 mm.
CNR-CC17	40 mm.	50 mm.	232 mm.
CNR-CC18	39 mm.	70 mm.	230 mm.



Rear Sill SWH-CC31

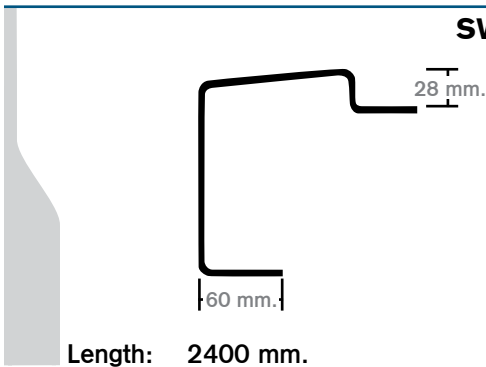

Body Parts

Roof

Roof Panels

Part Number	Ribs	Width	Length	Color
ROF-CC01	5	1045 mm.	2356 mm.	
ROF-CC02	4	1045 mm.	2356 mm.	
ROF-CC03	5	1045 mm.	2356 mm.	
ROF-CC05	3	1022 mm.	2730 mm.	
ROF-CC06	5	1045 mm.	600 mm.	
ROF-CC07	4	1144 mm.	2359 mm.	Evergreen
ROF-CC08	4	1144 mm.	600 mm.	Evergreen

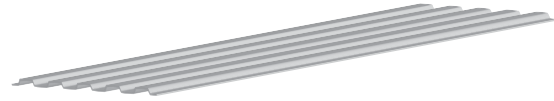

Roof Bow BOW-ST03

Cross Ref: Stoughton# 23-04006-000-00

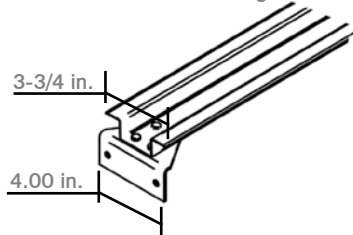

Material: Galvanized Steel with Clips
Length: 98-1/4 in. Hole Centers: 3 in.

Top End Header TOP-CC11

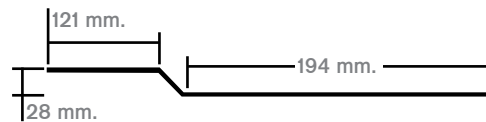

Length: 2400 mm.

Side Wall: Bottom Side Rails

BOT-CC01

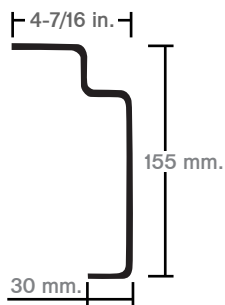

Length: 5702 mm.

BOT-CC02

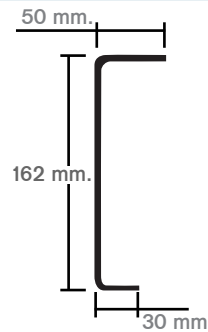

Length: 5702 mm.

Front BOT-CC03

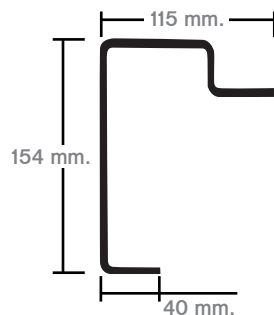

Length: 2400 mm.

Rear BOT-CC09



Material: Steel
Length: 70.00 in.

Appendix: Container/Chassis

APX

Container/Chassis

Body Parts

Side Wall: Bottom Side Rails

**Bottom Side Rail
BOT-CC10**

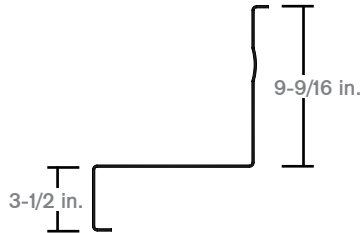

Material: Galvanized Steel
Length: 71 in.

**Bottom Side Rail Splice
BOT-CC11**



Material: Steel
Length: 40 in.

**Bottom Side Rail Splice
BOT-CC12**



Material: Steel
Length: 39-7/8 in.

**Bottom Side Rail
BUF1208-7935**

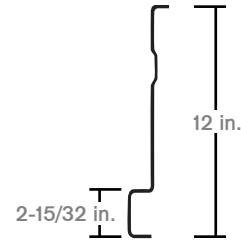

Material: Steel
Length: 228 in.

Side Wall: Panels

PNL-CC02

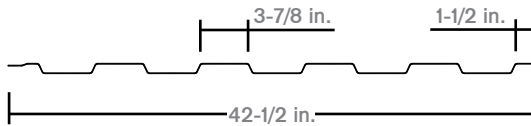

Material: Steel
Length: 98-5/8 in.

PNL-CC03

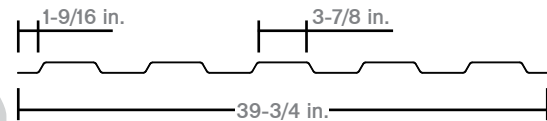

Material: Steel
Length: 98-5/8 in.

PNL-CC05

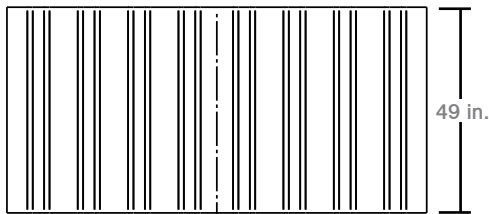

Material: Steel
Length: 107-15/16 in.

PNL-CC10

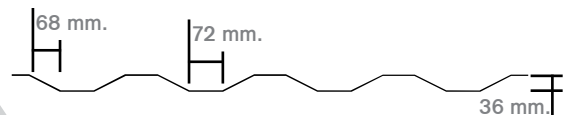

Type: Side
Width: 1116 mm. Ribs: 5
Length: 2700 mm.

Body Parts

Side Wall: Panels

PNL-CC11

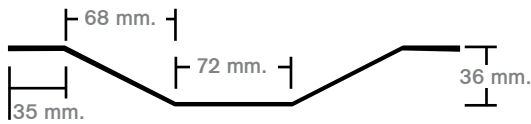

Type: Side
Width: 556 mm. Length: 150 mm.

PNL-CC12



Type: Side
Width: 556 mm. Length: 600 mm.

Part Number	Length	Width	Type
PNL-CC13	300 mm.	1116 mm.	Side
PNL-CC14	600 mm.		
PNL-CC15	2700 mm.		
PNL-CC18	2400 mm.		

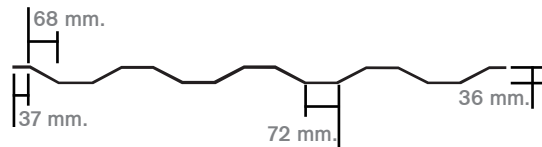

Side Wall: Posts

**Intermediate Inner
SPO-CC02**

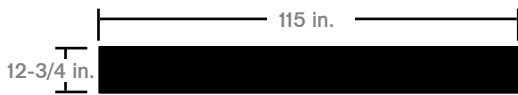

Material: Steel

**Intermediate Outer
SPO-CC03**



Material: Steel

**Hyundai Style
SPO-HY04**

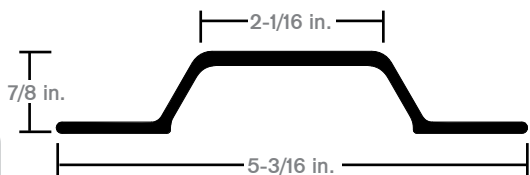

Material: Aluminum
Length: 108 in.

**Stoughton Style
SPO-ST01**

Cross Ref: Stoughton# 02-19144-107-56

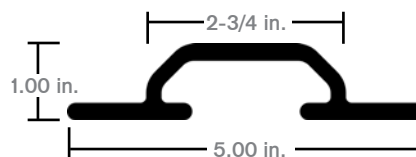

Material: Aluminum
Length: 107-9/16 in.

Appendix: Container/Chassis

Body Parts

Side Wall: Posts

SPO-ST04

Cross Ref: Stoughton# 02-13352-110-00

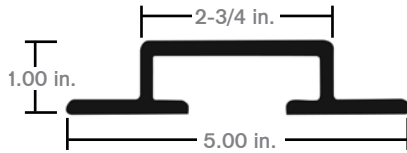
 Material: Aluminum
 Length: 110 in.

Side Wall: Top Rails

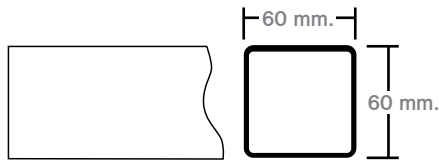
TOP-CC10

Length: 5702 mm.

Landing Gear

Atlas 55 Series

	Type	Travel	Footware / Additional
BINLG4009-7000E900	Set		
BINLG4009-7100E900	Non Gear Leg	17 in.	Low Profile Sandshoe, HD Solid Axle
BINLG4009-7200E900	Gear Leg		
BINLG4009-9000E900	Set		
BINLG4009-9100E900	Non Gear Leg	19 in.	Low Profile Sandshoe, HD Solid Axle
BINLG4009-9200E900	Gear Leg		

Capacities

Lifting Capacity - Rated	55,000 lbs.
100 ft. lbs. Input Torque	
Ultimate Load Capacity	170,000 lbs.
Side Load Capacity	30,000 lbs.

SAF-Holland

Landing Gear

Standard - Outside Mount

	Type	Travel	Footware / Additional
JOSA400.T18.17	Set		
JOSA400L.T18.17	Non Gear Leg	17 in.	Low Profile Sandshoe Solid Axle
JOSA400R.T18.17	Gear Leg		
JOSA400.T18.19	Set		
JOSA400L.T18.19	Non Gear Leg	19 in.	Low Profile Sandshoe Solid Axle
JOSA400R.T18.19	Gear Leg		



Capacities

Lifting Capacity - Rated	55,000 lbs.
100 ft. lbs. Input Torque	
Ultimate Load Capacity	160,000 lbs.
Side Load Capacity	29,000 lbs.

Jost

H-Style

	Type	Travel	Footware / Additional
PROLG100T18-17H	Set		
PROLG100T18-17H-1	Non Gear Leg	17 in.	Low Pro Shoe Univeral Mount Solid Axle
PROLG100T18-17H-2	Gear Leg		
PROLG100T18-19H	Set		
PROLG100T18-19H-1	Non Gear Leg	19 in.	Low Pro Shoe Univeral Mount Solid Axle
PROLG100T18-19H-2	Gear Leg		



H-Style Gear Kits

Gear Box Kit CMS2	HOLRK-11291
Bevel & Pinion Gear Repair Kit	HOLRK-11290

H-Style Capacities

Lifting Capacity - Rated	39,000 lbs.
100 ft. lbs. Input Torque	
Ultimate Load Capacity	140,000 lbs.
Side Load Capacity	27,000 lbs.

Pro-Par

Accessories

Solid Axle PROLG-AX03



Length: 8-1/4 in.
Material: Steel

Solid Axle Kit BUF1002-2775-KIT



Length: 8-3/8 in.
Capped

Appendix: Container/Chassis

APX

Container/Chassis

Lighting & Electrical

Single Diode Clearance / Marker

MCL11 Series

Uni-Lite 3/4 in. Round LED

Type	Color	
Lamp	Red	OPTMCL11RPG
Lamp	Yellow	OPTMCL11APG



(OPMCL11RPG) (OPTMCL11APG)

Accessories

Grommet
OPTA11GB

0.75 in. Round LED

Type	Color	
0.180 Bullet	Red	PETM176R-BT2
0.180 Bullet	Amber	PETM176A-BT2



(PETM176R-BT2)



(PETM176A-BT2)

2.00 in. Clearance / Marker Lamps

LumenX 190

2.00 in. Round LED

	Color	Type	Connection	Additional
PETM190FR	Red	Reflex Flange		
PETM190FA	Amber	Reflex Flange		
PETM190FR-CLP	Red	Reflex Flange		Locking Tabs
PETM190FA-CLP	Amber	Reflex Flange		Locking Tabs
PETM190FR-AMP	Red	Lamp w/ Hard-Shell Connector		
PETM190FA-AMP	Amber	Lamp w/ Hard-Shell Connector		



(PETM190FR/PETM190FR-AMP)



(PETM190FA/PETM190FA-AMP)

Accessories

Pigtail
PETB162-49
PETB192-492
Retaining Clip
PETB162-093

Model 30 Sealed 2.01 in. Round LED

Additional	Color	
Gray Flange	Red	TRU30051R
Gray Flange	Amber	TRU30051Y



(TRU30051R)



(TRU30051Y)

Accessories

Pigtail
TRU93745

Model 30 Sealed 2.00 in. Round

Type	Color	
Lamp	Red	TRU30200R
Lamp	Yellow	TRU30200Y



(TRU30200R)



(TRU30200Y)

Accessories

Pigtail
TRU94902

Lighting & Electrical

4.00 in. Stop / Tail / Turn Lamps

**814 Single Diode
4.00 in. Round LED**

Type	Color	
Gray Flange-Kit	Red	PETM814R



(PETM814R)

AMP Connector - PL3



Lamp Plug

Accessories

Pigtail
PETB817-49

**824 Single Diode
4.00 in. Round LED**

Type	Color	
Gray Flange-Kit	Red	PETM824R



(PETM824R)



Lamp Plug

Accessories

Pigtail
PETB431-491

Utility Lamps

**290 Great White
3.00 in. Rectangle**

Type	Color	
Top Mount	White	PETM290



**MicroNova
0.75 in. Round LED**

Additional	Color	CCM#	
Black Flange	White	GROTELICLT	GRT60721



Accessories

Grommet
GRT94360

Accessories

Plug Retention Clip

Color	
Stainless Steel	PETB162-093



Fits series 189 & 190 clearance side marker lights

Locking Ring, 1.50 in. Round

Color	
Stainless Steel	OPTA11SRB



Appendix: Container/Chassis

Safety, Security & Accessories

Container/Chassis

Corner Castings

Part Number	Location	Material
TWL-CC001	Bottom Left	Steel
TWL-CC002	Bottom Right	
TWL-CC003	Top Left	
TWL-CC004	Top Right	

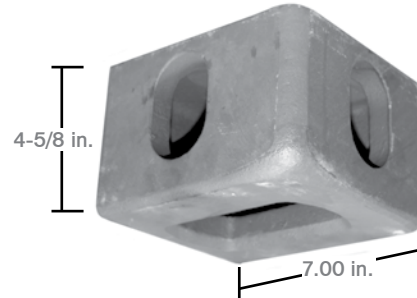

End Castings

Front Bolster

Part Number	Location
BOL-CC20	Curbside
BOL-CC21	Roadside



Vents

VNT-CC01

S Type Small Cigar Vent

Pro-Fit

VNT-CC02

Tal Type Vent

Pro-Fit

VNT-CC03

M Type Vent

Pro-Fit

VNT-CC04

Fits Jindo 48 ft., Pacer 53 ft. ABS plastic with rubber seal

Pro-Fit

Safety, Security & Accessories

Vents

Pro-Fit

VNT-CC05

Material: ABS Plastic with Rubber Seal
Fits: Shallow Panel

Tech Tip

Twistlock Online

Twistlock & Pinlock Components

Need more information on a particular twistlock?

Log into www.MyAuroraPlus.com for Aurora's Graphical Bill of Material (GBOM).

Easily point and click through our twistlocks to drill down to an individual assembly or component.

Suspension

Hutch - 8500 Slider Series

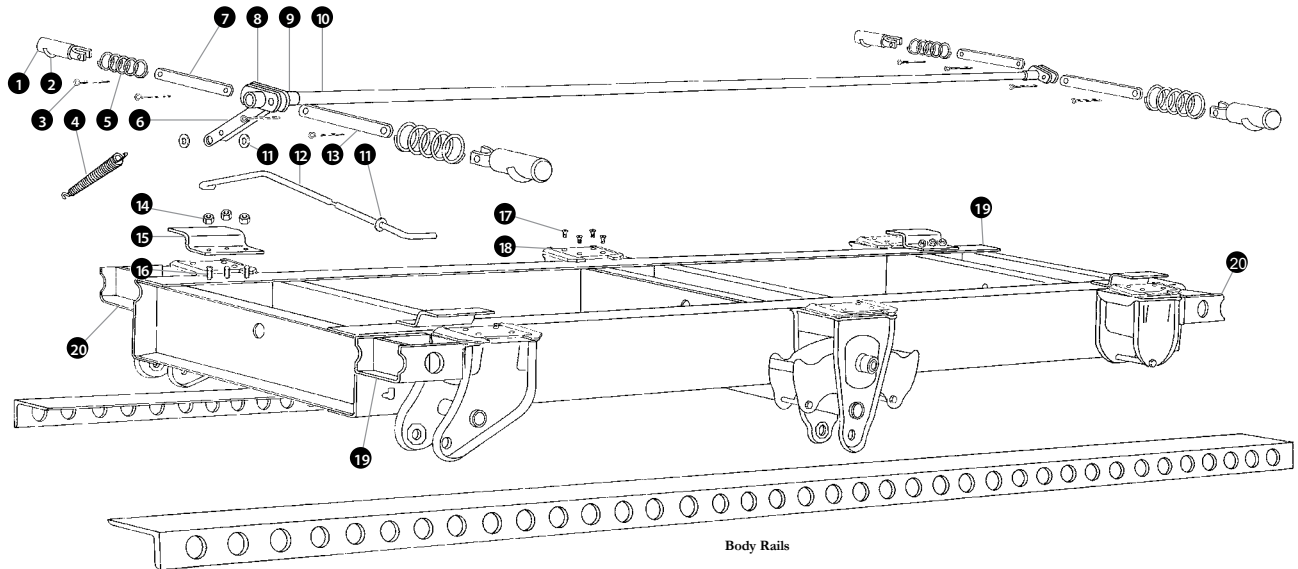

Item	Part Number	Description
1	HUT11410-02	Lock Pin Assembly - 9-3/16 in. LG
2	HUT11414-00	Special Half Washer
3	HUT8016-00	Cotter Pin - 3/8 in. x 1-1/4 in.
4	Spring	
	HUT8018-01	Helax, 12 GA x 1 PD x 8-5/8 in.
	HUT8018-02	Helax, 12 GA x 1 PD x 10-1/8 in.
5	HUT8098-01	Compression Spring - Lock Pin, PL
6	HUT8026-00	Crank - Puller Kit
7	Link	Spring Center Overall Length
	HUT11412-08	36 in. 11-5/8 in.
	HUT11412-02	37 in. 12-5/8 in.
	HUT11412-03	38 in. 13-5/8 in.
	HUT11412-05	42 in. 17-5/8 in.
	HUT11412-16	43 in. 18-5/8 in.
	11412-06^	44 in. 19-5/8 in.
8	HUT8028-00	Cam - Puller Kit
9	HUT405-72	Pipe - 1-1/4 in. STD x 1-3/8 in.
10	HUT8010-17	Pipe - 1 in. STD x 105 in.
11	HUT8054-00	Plain Washer - 5/8 in.
12	HUT8518-00	Pull Handle - 28 in. LG
13	HUT11412-03	Link - 13-5/8 in. OAL

Item	Part Number	Description
14	HUT33-01	Hex Lock Nut - 1/2 in.-20 UNF-2B, GRB
15	HUT8505-00	Slider Hold Down - Zee, 3/8 in. x 6 in.
16	HUT8040-00	Hex Bolt - 1/2 in.-20 UNF x 1-1/4 in. LG, GR5
17	HUT9627-00	Thrd Form Screw - 5/16 in.-18 x 3/4 in.CSHD
18	HUT12818-01	Slider Pad - 1/4 in. x 4 in. 5-1/2 in., UHMW
19	HUT8511-01	Cage Assembly - Lock Pin, LH
20	HUT8511-02	Cage Assembly - Lock Pin, RH

Body Rail Assemblies	Length	Nominal Adj.
HUT8178-01	176 in.	64 in.
HUT8178-02	192 in.	80 in.
HUT8178-03	216 in.	104 in.
HUT8178-04	240 in.	128 in.
HUT8178-05	168 in.	56 in.
8178-06^	228 in.	116 in.
HUT8178-07	200 in.	88 in.

Locator Bar Assemblies	Spring Centers
HUT11641-02	36 in.
HUT11641-04	37 in.
HUT11641-05	38 in.
HUT11641-10	42 in.
HUT11641-06	43 in.
HUT11641-07	44 in.

^Part included for reference only.

Suspension

Hutch - 9000 Slider Series

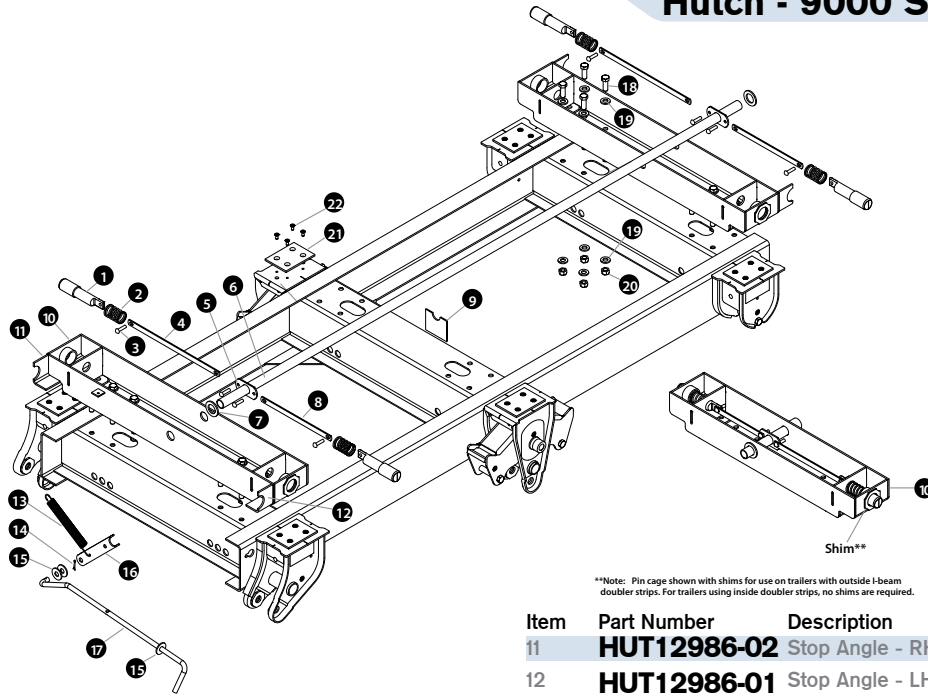

**Note: Pin cage shown with shims for use on trailers with outside I-beam doubler strips. For trailers using inside doubler strips, no shims are required.

Item	Part Number	Description
1	HUT16006-01	Forged Lock Pin
2	HUT12779-01	Compression Spring
3	HUT12780-01	Rivet - Button Head
4	Link	Spring Centers Overall Length
	HUT11412-25	36 in. 9-3/8 in.
	HUT11412-21	38 in. 11-3/8 in.
	HUT11412-40	43 in. 16-1/16 in.
	HUT11412-24	44 in. 17-3/8 in.
5	HUT8028-00	Cam - Puller Kit
6	HUT8010-16	Pipe - 1 in. STD x 99 in. LG
7	HUT9224-00	Washer - Flat, 3/16 in. Thick x 1-3/8 ID x 2-1/4 OD
8	HUT11412-20	Link - 13-3/8 in. OAL
9	HUT11202-00	Pipe Guide

Item	Part Number	Description
11	HUT12986-02	Stop Angle - RH
12	HUT12986-01	Stop Angle - LH
13	HUT8018-01	Return Spring
14	HUT551-00	Cotter Pin - 1/8in. - 1-1/4in. Steel
15	HUT8054-00	Plain Washer - 5/8in.
16	HUT8026-00	Crank - Puller Kit
17	HUT8518-03	Pull Handle - 28in. LG
18	HUT11512-05	Hex Bolt - 5/8in.-18 UNF 2A x 1-3/4in., GR8
19	HUT10273-00	Washer - 5/8in. Hardened
20	HUT11513-03	Hex Locknut - 5/8in.-18 UNF, 2B, GR C
21	HUT12818-01	Slider Pad - 1/4in. x 4in. x 5-1/2in., UHMWPE
22	HUT9627-00	Thrd Form Screw - 5/16in.-18 x 3/4in., CS HD

Locator Bar Assemblies	Spring Centers
HUT17635-01	36 in.
HUT17635-03	38 in.
HUT17635-04	43 in.
HUT17635-05	44 in.

10	Pin Cage Assembly	Pin Cage w/ Lock Pin Comp.	Spring Centers	Length	Shims
	HUT16238-01	HUT24476-01	36 in.	35-5/16 in.	No
	HUT16244-01	HUT24495-01	36 in.	35-11/16 in.	Yes
	HUT16238-03	HUT24476-02	38 in.	37-5/16 in.	No
	HUT16244-03	HUT24495-02	38 in.	37-11/16 in.	Yes
	HUT16238-30	HUT24476-04	43 in.	42 in.	No
	16244-19^		43 in.	42-11/16 in.	Yes
	HUT16238-05	HUT24476-03	44 in.	43-5/16 in.	No
	HUT16244-05	HUT24495-03	44 in.	43-11/16 in.	Yes

^Part included for reference only.

Suspension

Hutch - 9036i Slider

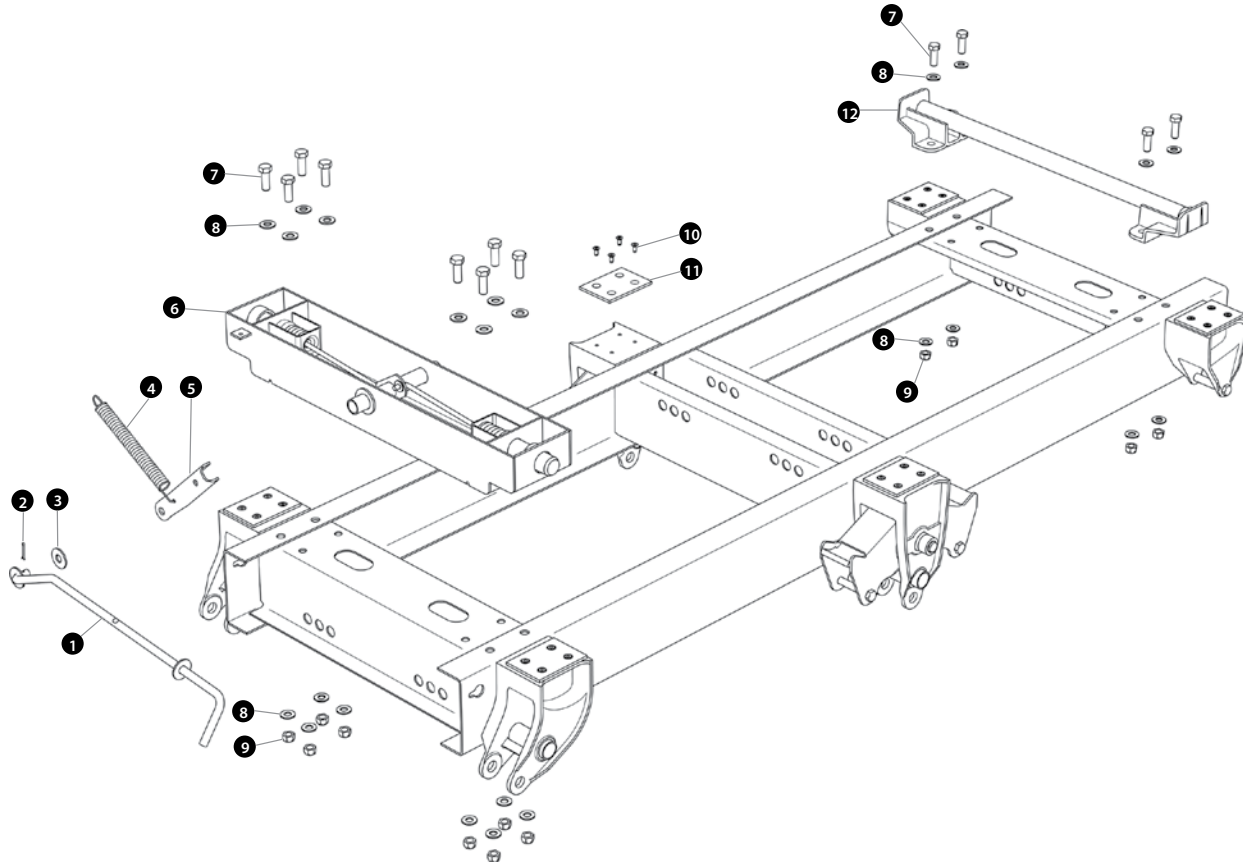

Item	Part Number	Description
1	24987-01 ^	Pull Handle
2	HUT551-00	Cotter Pin - 1/8in. x 1-1/4in.
3	HUT8054-00	Plain Washer - 5/8in.
4	HUT8018-02	Spring - Hel Ex, 1 PD x 10-1/8in. LG
5	HUT8026-00	Crank - Puller Kit
6	HUT24692-01	Lock Pin

Item	Part Number	Description
7	HUT11512-05	Hex Bolt - 5/8-18 UNF x 1-3/4 in. LG, GR8
8	HUT10273-00	Washers - 1/8in. x 21/32 ID x 1-5/16 OD
9	HUT11513-03	Hex Locknut - 5/8-18 UNF 2B, GRC
10	HUT9627-00	Thread Form Screw - 5/16-18 x 3/4, CS HD
11	HUT12818-01	Slide Pad - UHMWPE 1/4 x 4 x 5-1/2
12	HUT24425-01	Hold Down Assembly - Cast

Assemblies

	Includes
HUT24699-01	
HUT25614-02	Soft Coat Assembly Kit with Pin Cage
HUT25639-01	Assembly Kit with Pin Cage
HUT26022-01	Assembly Kit with Fabricated Hangers
HUT26156-01	Assembly Kit with Pin Cage, Hold, Down & RK

^Part included for reference only.

Suspension

Hutch - Series 10 Slider

Container/Chassis

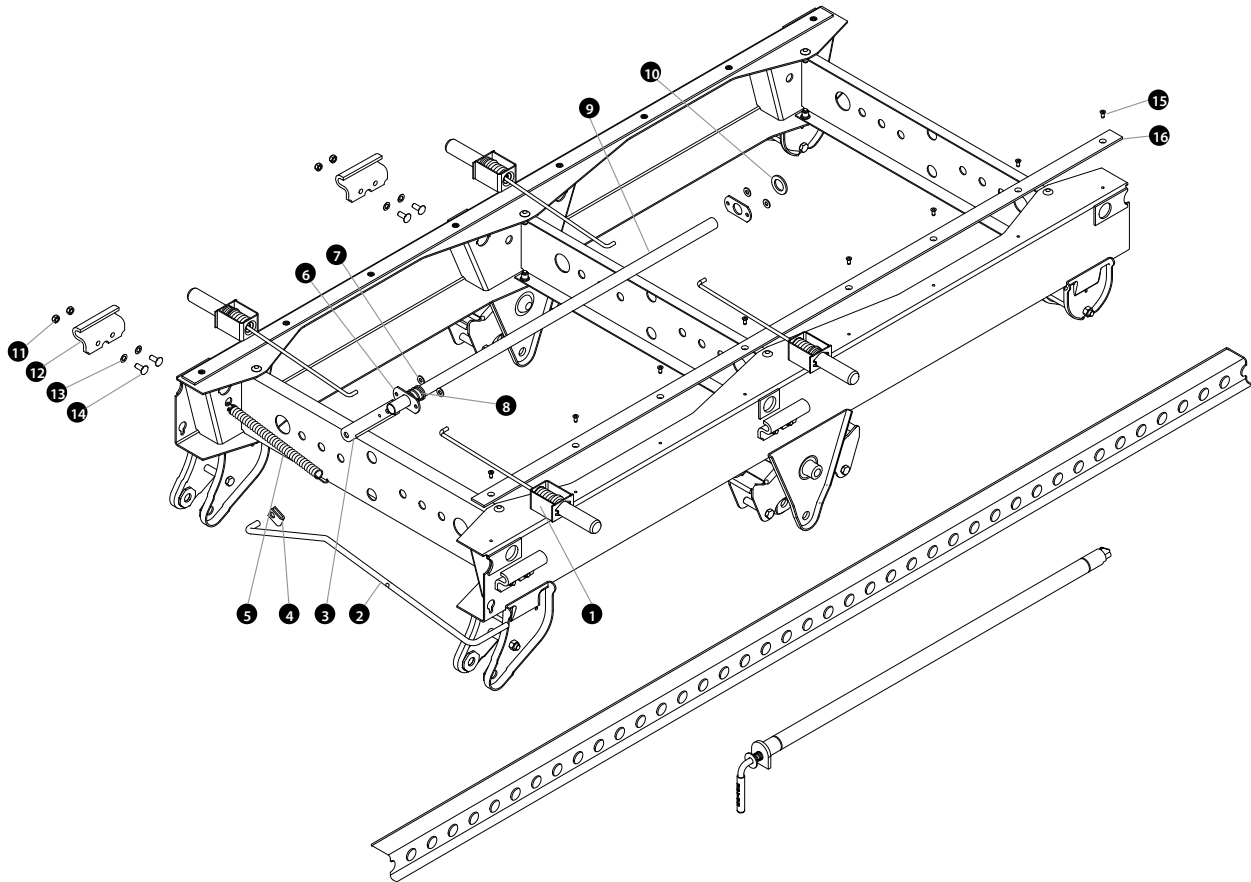

Item	Part Number	Description
1	HUT25590-01	EZ Pull Sub Assembly
2	HUT19468-01	Pull Handle
3	HUT19224-01	Crank
4	HUT11409-01	Handle Clip
5	HUT8018-02	Spring - Helix, 1 PD x 10-1/8in. LG
6	HUT8028-00	Cam - Puller Kit
7	HUT177-00	Flat Washer 3/8in.
8	HUT18064-01	Compression Spring
9	HUT8010-29	Pipe - 1in. STD x 50in. LG
10	HUT9224-00	Flat Washer
11	HUT33-01	Hex Locknut - 1/2 in.-20 UNF
12	HUT20289-01	Hold Down Clip
13	HUT25594-01	Push Bolt Retainer - 1/2 in. Bolt

Item	Part Number	Description
14	HUT25595-01	Carriage Bolt - 1/2in. - 20 UNF
15	HUT9627-00	Thread Form Screw - 5/16in.-18 x 3/4 in., CS HD
16	11421-32[^]	Slider Pad - 99in. LG
Body Rail Assemblies		Length
	HUT12713-XX*	100in. - 328in.
	HUT16816-XX*	120in. - 392in.
Locator Bar Assembly		Frame Width
	HUT11642-10	48in.

[^]Part included for reference only.
^{*}Part ending varies by length of material.

Appendix: Container/Chassis

Container/Chassis

Wheel End

		Wheel
	Size	
	22-1/2 in. x 8-1/4 in.	PROWH22582510HP2W
Pro-Par		
	Material: Steel	Piloted: Hub
	Mounting Holes: 10	Color: White
	Hand Holes: 2	

		Rim
	Size	
	22-1/2 in. x 8-1/4 in.	PROWH225825TLDMRW
Pro-Par		
	Material: Steel	Color: White

Steel Spacer Bands

		Smooth
Color	Size	
White	20.00 in. x 4.00 in.	LSASB4020K
Pro-Par		
	Material: Steel	

		Corrugated
Color	Size	
White	20.00 in. x 4.00 in.	ACC4020CSB
Accuride		
	Material: Steel	

Tubes

		Inner Tube
		TUB10.00-20
Pro-Par		
	Size: 10.00 - 20	Includes: 5 in. TR78A Valve Stem

		Tire Flap
		TUB20FLAP
Pro-Par		
	Size: 20 in.	Notes: Wheel Liner